

cerniere automatiche / automatic hinges

serie Collio



8680



8681



Alluminio / Aluminium - finiture / colors 02-05-13-14-15-16-17-22-60-62

COLLIO è la nuova cerniera per porte a peso ridotto completa di ammortizzatore a polimero e sistema di chiusura automatica. Nasce per porte intelaiate e partizioni ed è perfettamente compatibile con il profilo P35E. COLLIO è l'evoluzione della cerniera 8610; la prima cerniera automatica conosciuta dal mercato. Uno dei nostri bestsellers. Abbinabile a serrature magnetiche. Adatto per applicazioni in ambienti bagno e box doccia.

COLLIO es la nueva bisagra para puertas con peso reducido, completa de amortiguador a polímero y sistema de cierre automático. Fue ideada para puertas con marco y en particiones y es perfectamente compatible con los perfiles P35E. COLLIO es la evolución de nuestra bisagra 8610, la primera bisagra automática en el mercado y una de las más vendidas. Se puede combinar con cerraduras magnéticas. Adecuado para aplicaciones en baños y mamparas de ducha.

COLLIO is the new hinge for lightweight doors, featuring polymer-activated damper and automatic closing system. It is conceived for framed doors and partitioning and is perfectly compatible with P35E profiles. COLLIO is the evolution of our hinge 8610, the first-ever automatic hin-

ge on the market and one of our bestsellers. Can be combined with magnetic locks. Suitable for applications in bathrooms and shower enclosures

COLLIO ist das neue Scharnier für leichte Türen mit Polymer-Stoßdämpfer und automatischem Schließsystem. Es ist für gerahmte Türen und Trennwändekonzipiert, und ist perfekt kompatibel mit dem P35E-Profil. COLLIO ist die Weiterentwicklung unseres Scharniers 8610, des ersten automatischen Scharniers auf dem Markt und eines unserer Bestseller. Kann mit Magnetschlössern kombiniert werden. Geeignet für Anwendungen in Badezimmern und Duschtrennungen.

COLLIO est la nouvelle charnière pour portes légères, avec amortisseur en polymère et système de fermeture automatique. Il est conçu pour les portes à cadre et les cloisons et est parfaitement compatible avec le profil P35E. COLLIO est l'évolution de notre charnière 8610, la toute première charnière automatique du marché et l'une de nos meilleures ventes. Peut être combiné avec des serrures magnétiques. Convient pour les applications dans les salles de bains et les cabines de douche.



8680

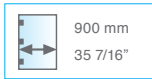
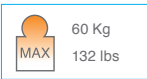
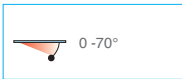
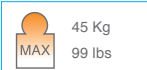
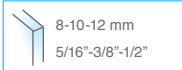

• Cerniera automatica vetro-muro per porte in battuta.

• Bisagra automática vidrio-pared para puertas con tope.

• Automatic hinge glass-wall for doors with stop.

• Automatikscharnier Glas-Wand für Anschlagtüren.

• Charnière automatique verre-mur pour porte à butée.

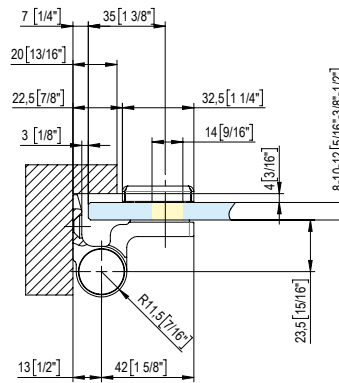
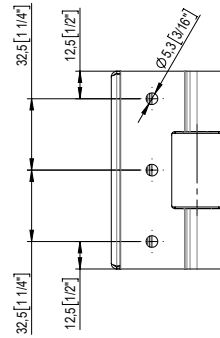
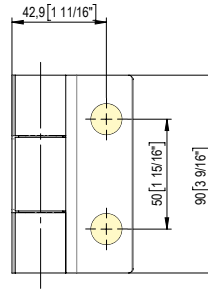
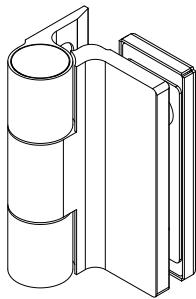

8681

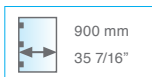
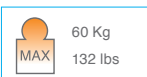
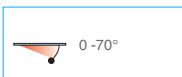
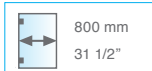
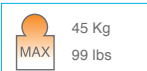
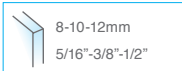

• Cerniera a scatto vetro-vetro 180° per porte in battuta.

• Bisagra con retención vidrio-vidrio 180° para puertas con tope.

• Automatic hinge glass to glass 180° for doors with stop.

• Automatikscharnier Glas-Glas 180° für Anschlagtüren.

• Charnière automatique verre-verre 180° pour porte à butée.

