

VT 101E10 VERTO

colcom **OILDYNAMIC** • REGOLABILE / ADJUSTABLE

MAX 100 Kg - 220 lbs

Porte - Doors

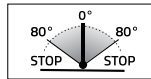
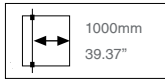

Alluminio / Aluminium : 02-05-14-15-16-17-31-32-RAL-62

- Cerniera oleodinamica, **integrata di freno** e regolazioni della velocità di chiusura e dello scatto finale dell'anta. Abbinabile anche con tutti i patch fittings della serie Maxima. Utilizzabile anche per applicazioni pivotanti. Stop a 0° +90° -90°.
- Bisagra automática hidráulica, **integrada de freno** y ajuste de velocidad de cierre y de disparo final de la puerta. Combinable con todos los herrajes producidos de serie Maxima. Utilizable también en aplicaciones con "punto de giro". Stop a 0° +90° -90°.
- Hydraulic hinge **including brake**, closing speed & final latch adjustments. Can be combined with all patch fittings of the Maxima series. Useful also for pivoting applications. Stop at 0° +90° -90°.
- Hydraulischcharnier **mit Bremse**, Feststellung der Türschließgeschwindigkeit und Feststellung der Endauslösung der Tür. Passend zu allen Produkten der Maxima Serie. Auch für schwenkenden Installationen geeignet. Feststellung bei 0° +90° -90°.
- Charnière hydraulique, **avec frein** et réglage de la vitesse de fermeture et de verrouillage. Combinable avec toutes les fixations de raccord de la série Maxima. Utilisable pour application pivo tante. Arrêt à 0°, +90° et -90°.

L'automatismo di chiusura inizia a operare entro un range compreso tra 70° e 80°. La chiusura è soft per i primi 20°, e regolabile con controllo dai 60° fino a chiusura completa.
 The closing automatism kicks in within 70°-80° range. The closing is soft for the first 20° and becomes speed-adjustable from 60° up to complete closing.

DISPONIBILE ANCHE NELLA VERSIONE "L" LIGHT CON MOLLA DEPOTENZIATA PER PORTE DI LARGHEZZA INFERIORE A 600 MM.
 Versione da specificare in fase d'ordine e soggetta a possibili minimi d'ordine. Per ulteriori informazioni contattare l'ufficio commerciale.
 ALSO AVAILABLE IN „L“ LIGHT VERSION WITH POWER-DOWNGRADED SPRING FOR DOORS WITH LESS THAN 600 MM.
 Version must to be specified on being ordered and could be subjected to minimum quantity order. For further information, please get in touch with the export department.

Classificazione secondo normativa - Clasificación según la ley - Classification according to int'l regulation Klassifizierung nach den Vorschriften - Classification selon la norme					
UNI EN 1154 : 2006	4	8	3/5	0	1 4

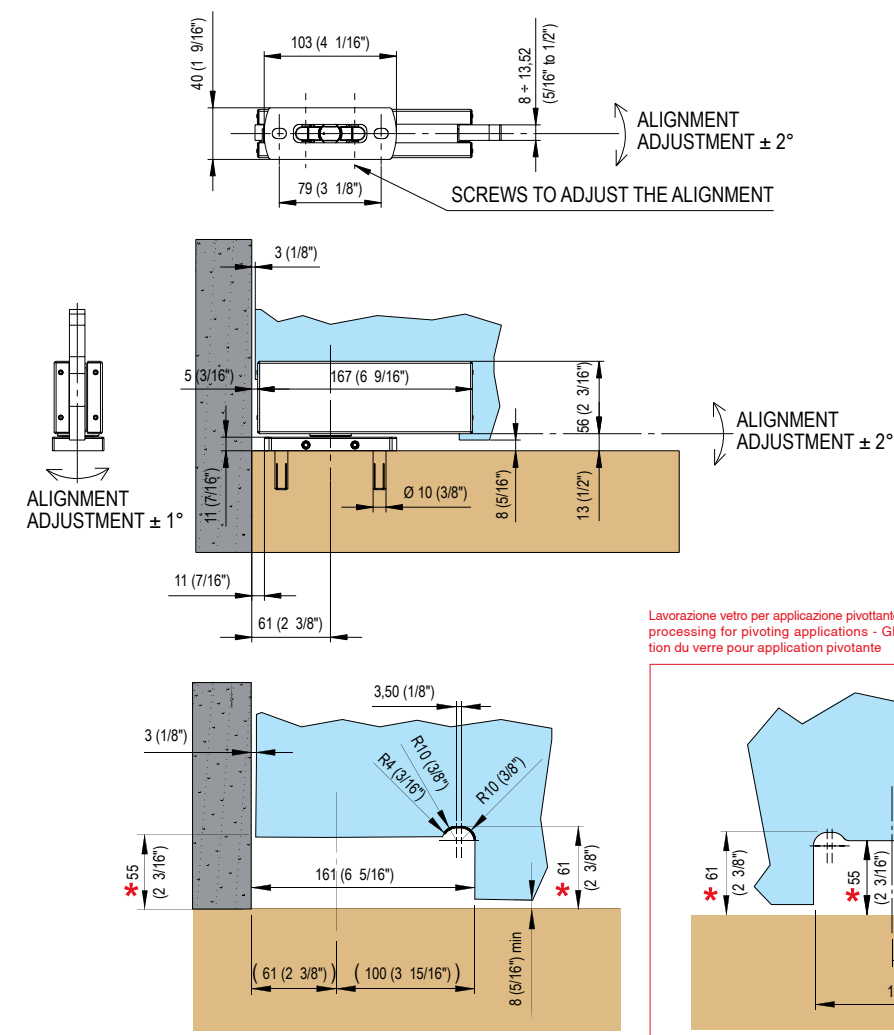

Lavorazione vetro per applicazione pivotante - Labrado del vidrio en aplicación con "punto de giro" - Glass processing for pivoting applications - Glasbearbeitung für schwenkende Installation Transformation du verre pour application pivotante

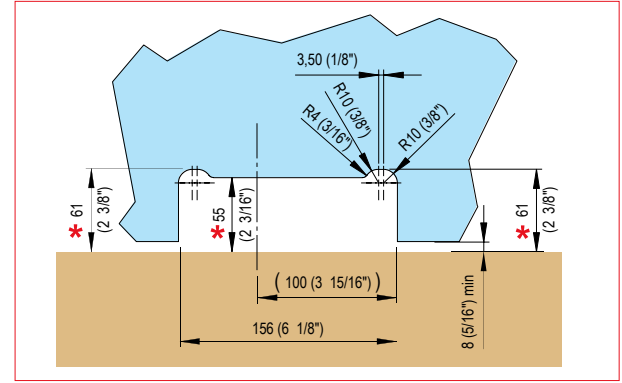

* DISTANZA DA TERRA - DISTANCIA DESDE EL SUELO - DISTANCE FROM THE FLOOR - ABSTAND VOM BODEN - DISTANCE AU SOL

VT 100E20 VERTO

FREE HINGE

100 Kg - 220 lbs

Porte - Doors

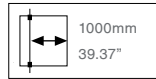

- Cerniera superiore.
- Bisagra superior.
- Top hinge.
- Oberes Band.
- Charnière supérieure.

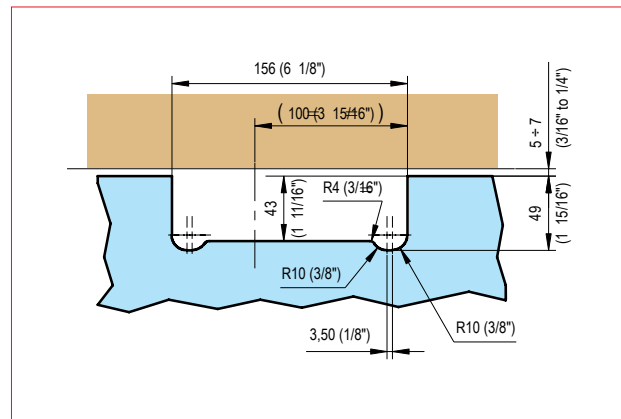
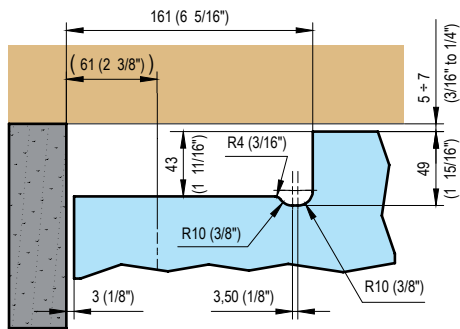
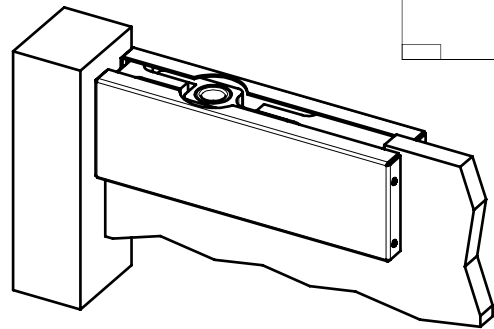
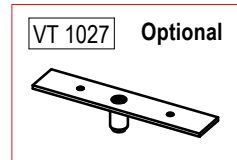
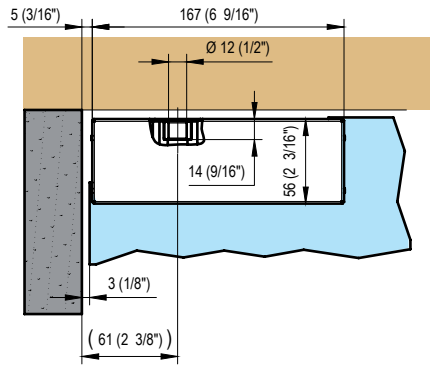
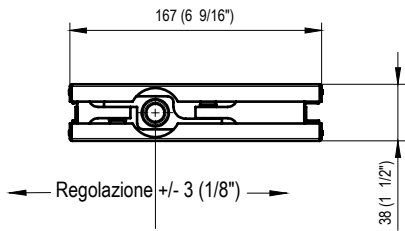

Lavorazione vetro per applicazione pivotante - Labrado del vidrio en aplicación con "punto de giro" - Glass processing for pivoting applications - Glasbearbeitung für schwenkende Installation - Transformation du verre pour application pivotante

VT 100E25 VERTO

MAX 100 Kg - 220 lbs

Porte - Doors

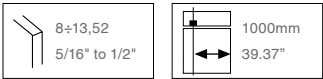

- Attacco sopra luce per art. VT 100E20.
- Enganche de giro montante para art. VT 100E20.
- Transom link fitting for item VT 100E20.
- Kupplung für Oberlichtfenster für art. VT 100E20.
- Imposte art.100E 20.



VT A100E40 VERTO

- Piastrina per attacco a muro per art. VT 100E25.
- Accesorio para la fijación a pared para art. VT 100E25.
- Wall fixing accessory for item VT 100E25.
- Zubehör für Wandfixierung für Art. VT 100E25.
- Plaque pour montage mural art. VT 100E25.



APPLICAZIONE - APLICACIÓN - APPLICATION - ANWENDUNG - APPLICATION

VT 100E25

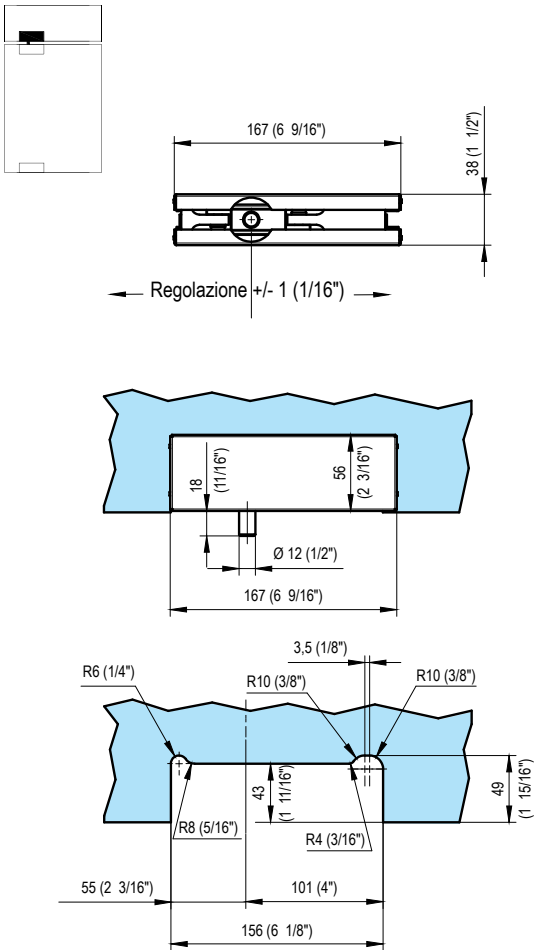

APPLICAZIONE - APLICACIÓN - APPLICATION - ANWENDUNG - APPLICATION

VT 100E25 + VT A100E40

