

835E10N SOL Biloba Evo

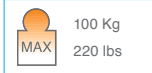

- Cerniera libera vetro-muro per porte in battuta. Da abbinare con 835E10N-835E11N. Si installa su porte con profilo in battuta. Profondità stipite da 30 a 50 mm.
- Bisagra libre pared-vidrio para puertas con tope. Para utilizar junto con 835E10N-835E11N. Se instala en puertas con perfil con batida. Profundidad estipite entre 30 y 50 mm.
- Free hinge wall-glass for doors with stop. To be matched with 835E10N-835E11N. Installed on doors with a profile on a stop. Jamb depth from 30 to 50 mm.
- Freies Band Glas-Wand für Anschlagtüren. Zur Kombination mit 835E10N-835E11N Man kann es auf Türen mit Rahmen benutzen. Pfostentiefe von 30 bis 50 mm.
- Charnière libre verre-mur pour porte à butée. A combiner avec les références 835E10N-835E11N. S'installe sur porte à butée avec profil. Profondeur de jamba-ge 30 à 50 mm.

835E10NSOL R = destra - derecha - right - rechts - droite
 835E10NSOL L = sinistra - izquierda - left - links - gauche

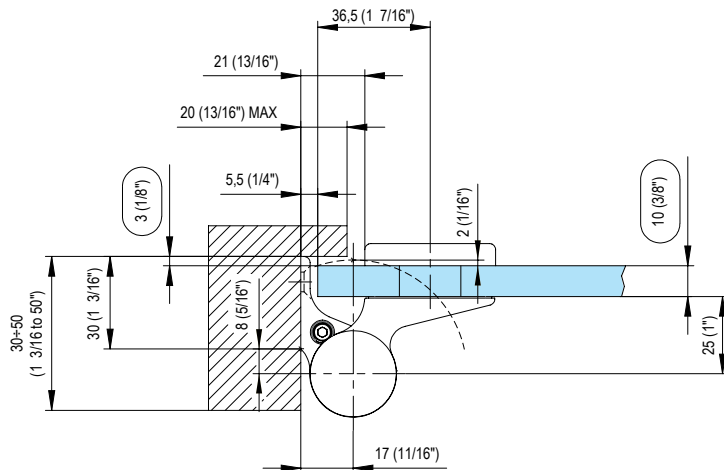
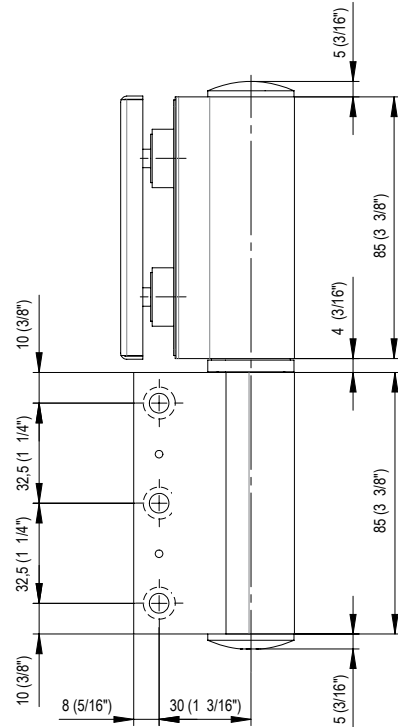
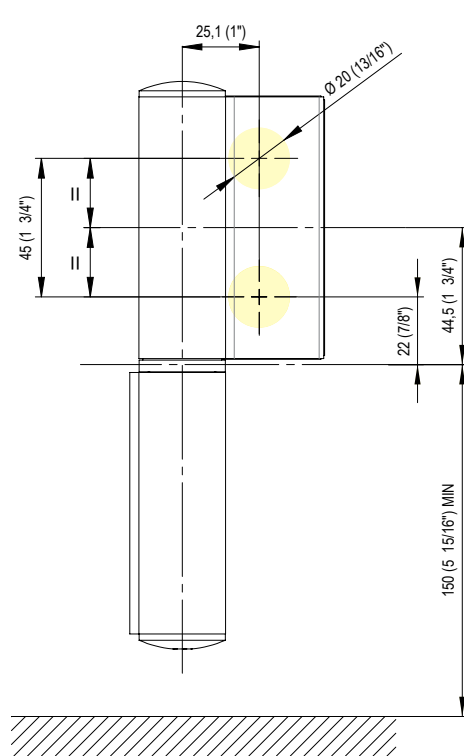
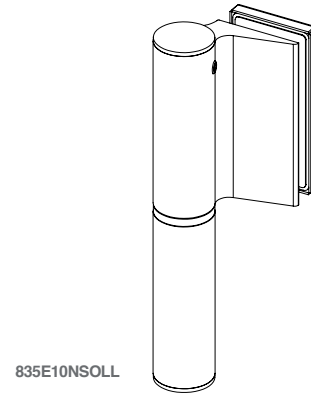

835E50SOL

Biloba Evo

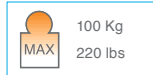
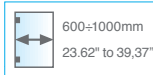
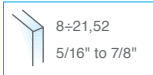

- Cerniera libera vetro-vetro per porte in battuta.
Da abbinare con 835E50-835E51.
- Bisagra libre vidrio-vidrio para puertas con tope.
Para utilizar junto con 835E50-835E51.
- Free hinge glass-glass for doors with stop.
To be matched with 835E50-835E51.
- Freies Band Glas-Glas für Anschlagtüren.
Zur Kombination mit 835E50-835E51.
- Charnière libre verre contre verre pour porte avec butée.
A combiner avec les références 835E50-835E51.

835E50 SOL R = destra - derecha - right - rechts - droite
835E50 SOL L = sinistra - izquierda - left - links - gauche

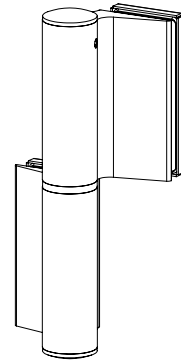

835E50SOLL

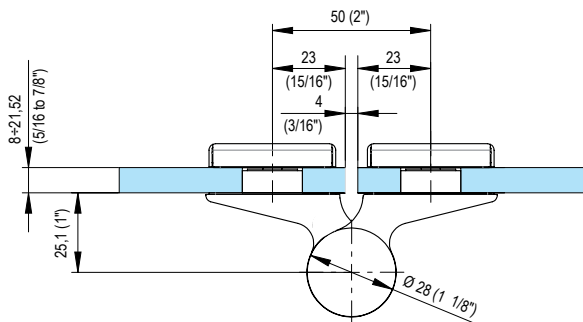
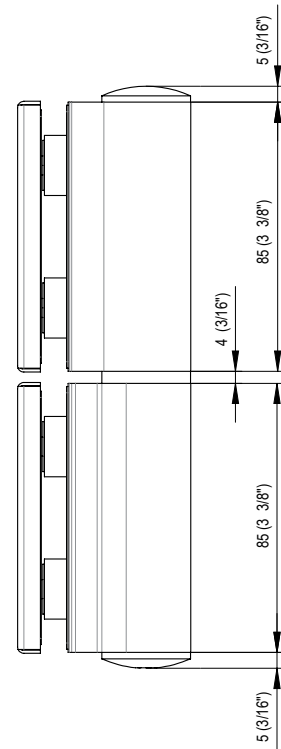
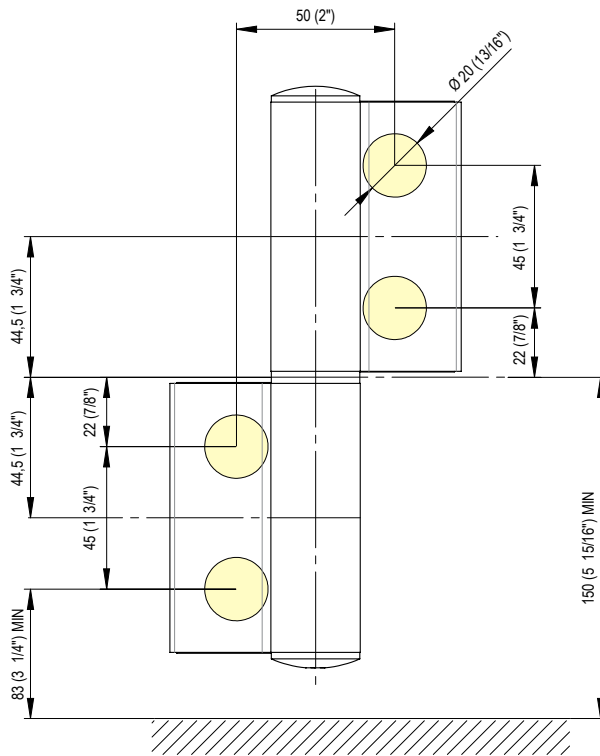

835E50SOL

835E50-51

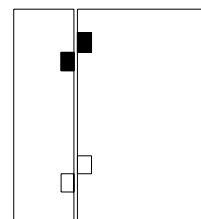

Riepilogo applicazioni disponibili con Biloba EVO. Chiusura automatica da 90° e 180° Biloba EVO applications summary. Automatic closing from 90° to 180°

SOLUZIONE - SOLUTION 1

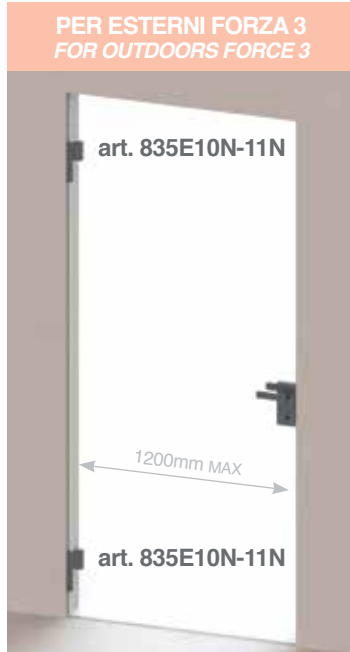

SOLUZIONE - SOLUTION 2

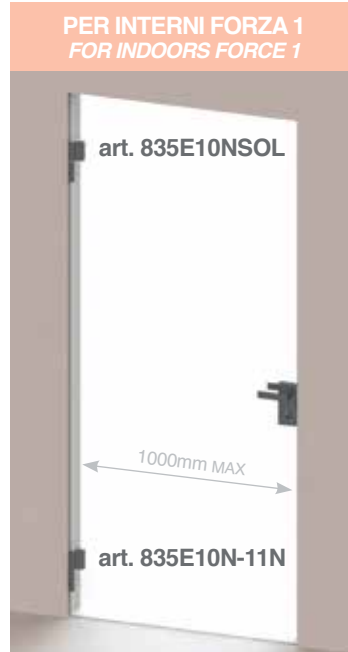

SOLUZIONE - SOLUTION 3

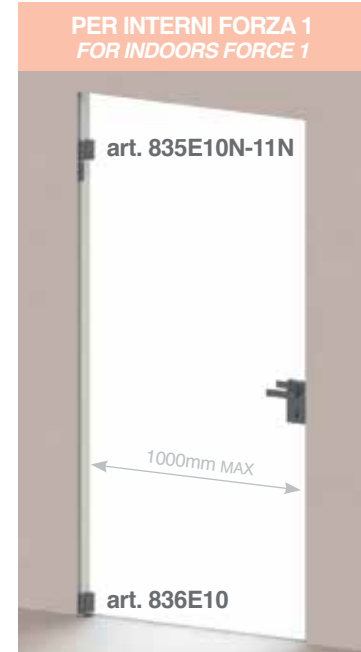

- 2 cerniere Biloba EVO nella versione standard
- Disponibile nelle versioni vetro-muro art.835E10 e vetro-vetro art. 835E50
- Per porte fino a 120 kg
- Anta da 800mm a 1200 mm
- Sp. vetro 8-21.52 mm
- Per esterni
- Forza 3

- 2 bisagras Biloba EVO versión standard
- Disponible en las versiones pared-vidrio art.835E10 y vidrio-vidrio art.835E50
- Para puertas hasta 120 kg
- Ancho de puerta de 800mm a 1200 mm
- Espesor de vidrio 8-21.52 mm
- Para exteriores
- Fuerza 3

- 2 Biloba EVO hinges in the standard version
- Available glass-to-wall, item 835E10 and glass-to-glass item 835E50
- For doors up to 120 kg
- Door width from 800 mm to 1200 mm
- Glass thickness 8 - 21.52 mm
- For outdoors
- Force 3

- 2 Hydraulikbänder Biloba EVO Standard Version
- Verfügbar in der Ausführung Glas-Wand Art.835E10 und Glas-Glas Art. 835E50
- Für Glastüren bis 120 kg
- Türbreite von 800mm bis 1200 mm
- Glasdicke 8-21.52 mm
- Für Außen
- Stärke 3

- 2 charnières Biloba EVO dans la version standard
- Disponible dans les versions verre-art.835E10 et verre-verre art.835E50
- Pour portes jusqu'à 120 kg
- Battant de 800mm à 1200 mm
- Ép. verre 8-21.52 mm
- Pour extérieur
- Force 3

- 1 cerniera Biloba EVO standard 1 cerniera Biloba Evo Libera
- Disponibile nelle versioni vetro-muro art.835E10SOL e vetro-vetro art.835E50SOL
- Per porte fino a 100 kg
- Anta da 600mm a 1000 mm
- Sp. vetro 8-21.52 mm
- Per interni
- Forza 1

- 1 bisagra Biloba EVO standard 1 bisagra Biloba Evo Libre
- Disponible en las versiones pared-vidrio art.835E10SOL y vidrio-vidrio art.835E50SOL
- Para puertas hasta 100 kg
- Ancho de puerta de 600mm a 1000 mm
- Espesor de vidrio 8-21.52 mm
- Para interiores
- Fuerza 1

- 1 standard Biloba EVO 1 free Biloba Evo
- Available glass-to-wall, item 835E10SOL and glass-to-glass item 835E50SOL
- For doors up to 100 kg
- Door width from 600 mm to 1000 mm
- Glass thickness 8 - 21.52 mm
- For indoors
- Force 1

- 1 Hydraulikband Biloba EVO Standard 1 Hydraulikband Biloba Evo mit Freilauf
- Verfügbar in den Ausführungen Glas-Wand Art.835E10SOL und Glas-Glas Art.835E50SOL
- Für Glastüren bis 100 kg
- Türbreite von 600mm bis 1000 mm
- Glasdicke 8-21.52 mm
- Für Innenräume
- Stärke 1

- 1 charnière Biloba EVO standard et 1 charnière Biloba Evo Libre
- Disponible dans les versions verre-mur art.835E10SOL et verre-verre art.835E50SOL
- Pour portes jusqu'à 100 kg
- Battant de 600mm à 1000 mm
- Ép. verre 8-21.52 mm
- Pour intérieur
- Force 1

- 1 cerniera Biloba EVO standard 1 cerniera Biloba Evo Libera fissaggio a terra
- Disponibile nella versioni vetro-muro art.836E10
- Per porte fino a 100 kg
- Anta da 600mm a 1000 mm
- Sp. vetro 8-21.52 mm
- Per interni
- Forza 1

- 1 bisagra Biloba EVO standard 1 bisagra Biloba Evo libre fijación a suelo
- Disponible en la versión pared-vidrio art.836E10
- Para puertas hasta 100 kg
- Ancho de puerta de 600mm a 1000 mm
- Espesor de vidrio 8-21.52 mm
- Para interiores
- Fuerza 1

- 1 standard Biloba EVO 1 lower free Biloba Evo
- Available glass-to-wall item 836E10
- For doors up to 100 kg
- Door width from 600 mm to 1000 mm
- Glass thickness 8 - 21.52 mm
- For indoors
- Force 1

- 1Hydraulikband Biloba EVO Standard 1 Hydraulikband Biloba Evo. Mit Freilauf und Befestigung am Boden
- Verfügbar in der Ausführung Glas-Wand Art.836E10
- Für Glastüren bis 100 kg
- Türbreite von 600mm bis 1000 mm
- Glasdicke 8-21.52 mm
- Für Innenräume
- Stärke 1

- 1 charnière Biloba EVO standard et 1 charnière Biloba Evo. Libre fixation au sol
- Disponible dans les versions verre-mur art.836E10
- Pour portes jusqu'à 100 kg
- Battant de 600mm à 1000 mm
- Ép. verre 8-21.52 mm
- Pour intérieur
- Force 1