



INOX-SLIDE System

PORTE SCORREVOLI

Sistema puertas correderas

Sliding doors systems

Schiebetüren systeme



We Build the Invisible

colcomgroup.it

follow us on [f](#) [y](#) [t](#) [in](#)

webuildtheinvisible.com

follow us on [f](#) [ig](#) [y](#) [in](#)



Minusco propone un sistema scorrevole prodotto da SADEV e completamente realizzato in acciaio inox AISI 304 . Quest'ultima caratteristica lo rende decisamente interessante sia tecnicamente che esteticamente, oltre all' ottimo rapporto qualità prezzo. Lo scorrevole inox è adatto ad una vasta gamma di contesti architettonici sia moderni e minimali che in ristrutturazioni di edifici storici . Può essere fissato a muro oppure direttamente sul vetro ed è previsto ad anta singola oppure doppia anta. La semplicità d'installazione e regolazione (viene venduto in semplici kit completi), lo rendono particolarmente amato dai numerosi installatori in Italia e nel Mondo .

Los nuevos sistemas de puertas correderas que Minusco ofrece, son las de Sadev. Están producidos en acero AISI 304. Esta peculiaridad pone los nuevos sistemas muy interesantes por sus técnica, sus estética, sus precios y calidad. Estos sistemas de correderas en acero, se ponen interesantes en un contexto arquitectónico moderno y en remodelación. Pueden ser fijados a la pared o a vidrio; se prevehe uso con hoja simple o doble. El ajuste es simple. Se vende en kit y – por esto – le gusta a los instaladores en Italia y en el mundo.

Minusco proposes a sliding system produced by SADEV and realized completely in stainless steel AISI 304. This latter characteristic makes it certainly interesting both technically and aesthetically. It also has an excellent prices-quality ratio. The sliding stainless steel is suitable for a wide range of architectural contexts, both on minima list and also for historic building restructuring. It may be fixed directly on the wall or on the glass and it has been designed with single or double glaze. Thanks to an easy installation and adjustment (sold in simple complete sets) it is particularly appreciated by many installers in Italy and in the world.

Minusco führt ein Schiebesystem ein, der vom Sadev völlig aus Edelstahl AISI 304 hergestellt ist. Diese letzte Eigenschaft macht ihm vom technischen und ästhetischen Gesichtspunkt sehr interessant, das Verhältnis Qualität-Preis ist auch sehr gut. Das Schiebesystem aus Edelstahl ist für eine sehr breite Reihe von architektonischen Kontexten: modernen, minimalen und in Umstrukturierungen historischer Gebäude geeignet. Es kann an der Wand oder direkt am Glas fixiert sein und es ist mit Einzelante oder Doppelante vorgesehen. Die Einfachheit der Installation und der Einstellung (man verkauft ihm in einfachen und kompletten Kits) machen ihm vom vielen Installateuren in Italien und in der ganzen Welt sehr geliebt.





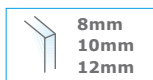

BV00/08 (8mm)
BV00/10 (10mm)
BV00/12 (12mm)

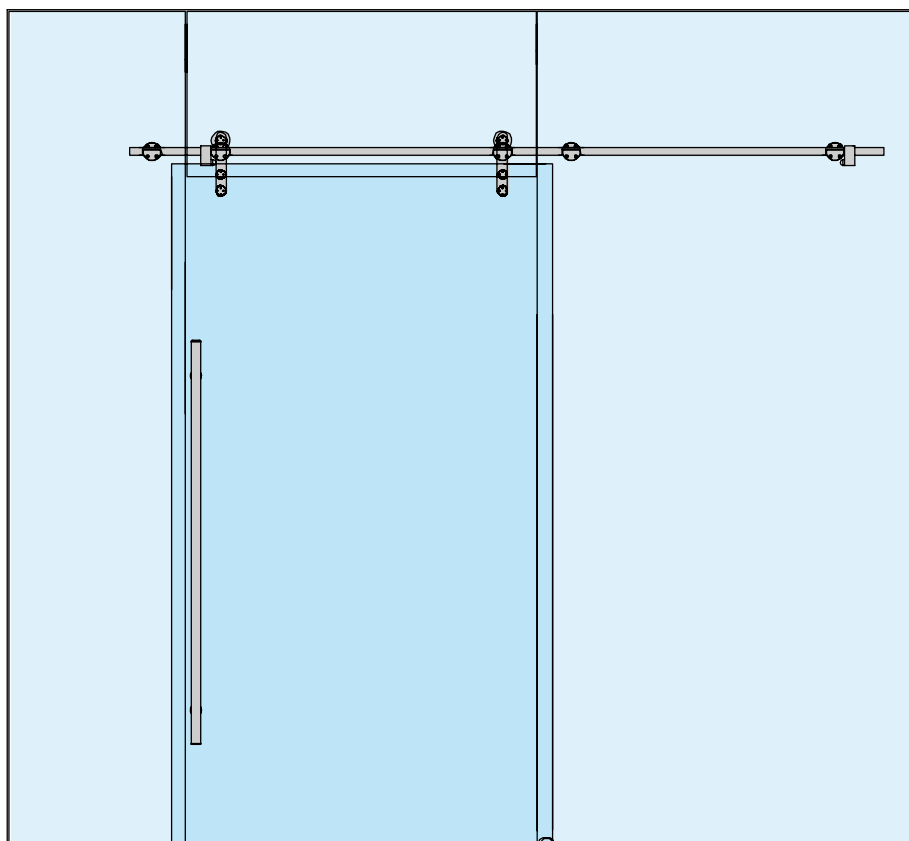

- Kit scorrevole ad un anta.
Fissaggio su vetro .
- Kit para una puerta.
Fijación en el vidrio.
- One-leaf sliding door kit.
Glass mount.
- Set Schiebetüren mit einem Flügel. Befestigung auf Glas.



in kit

2X	BV10		Pinza per vetro.
			Pinza por vidrio.
			Grip for glas.
			Zange für Glas.
2X	BV30		Fermo fine corsa.
			Seguro.
			Limit stop.
			End-stopp.
1X	BV40		Binario con tappi di chiusura: Ø25mm L=3000mm.
			Via con tapónes: Ø25mm L=3000mm.
			Track with closing plug:diameter 25mm L=3000mm.
			Anbringen des Gleises an das Glas einschliesslich anti-abtrennelement.
5X	BV70/08 (8mm) BV70/10 (10mm) BV70/12 (12mm)		Attacco del binario a vetro comprensivo di antisganciamento
			Enganche de la via a vidrio, con seguro.
			Attachment of the track to the glass inclusive anti-detachment element.
			Anbringen des Gleises an das Glas einschliesslich anti-abtrennelement.
1X	BN50		Guida a terra.
			Guja al suelo.
			Floor guide.
			Boden-führung.

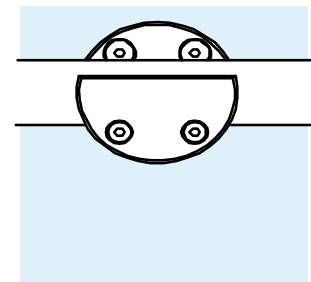
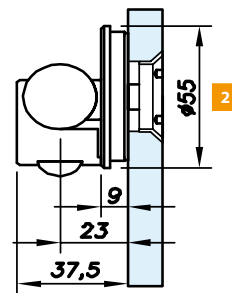
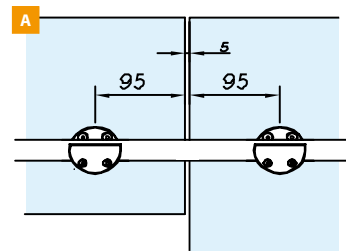
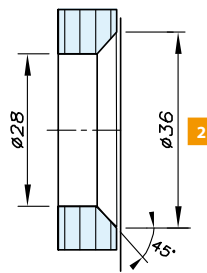
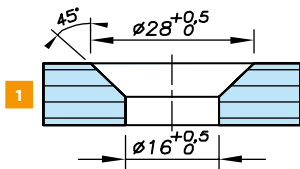
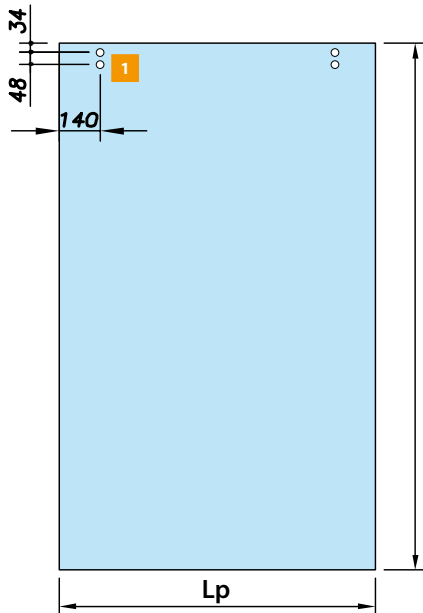
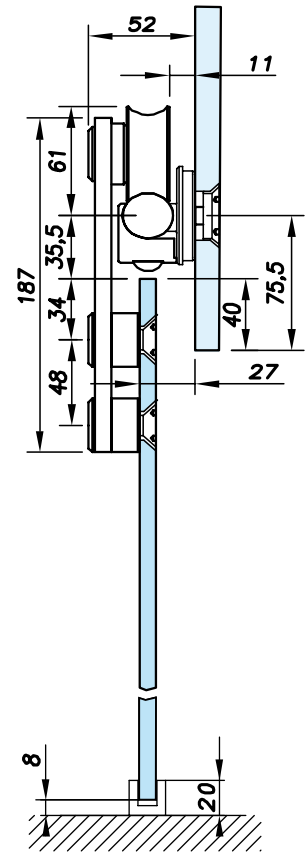
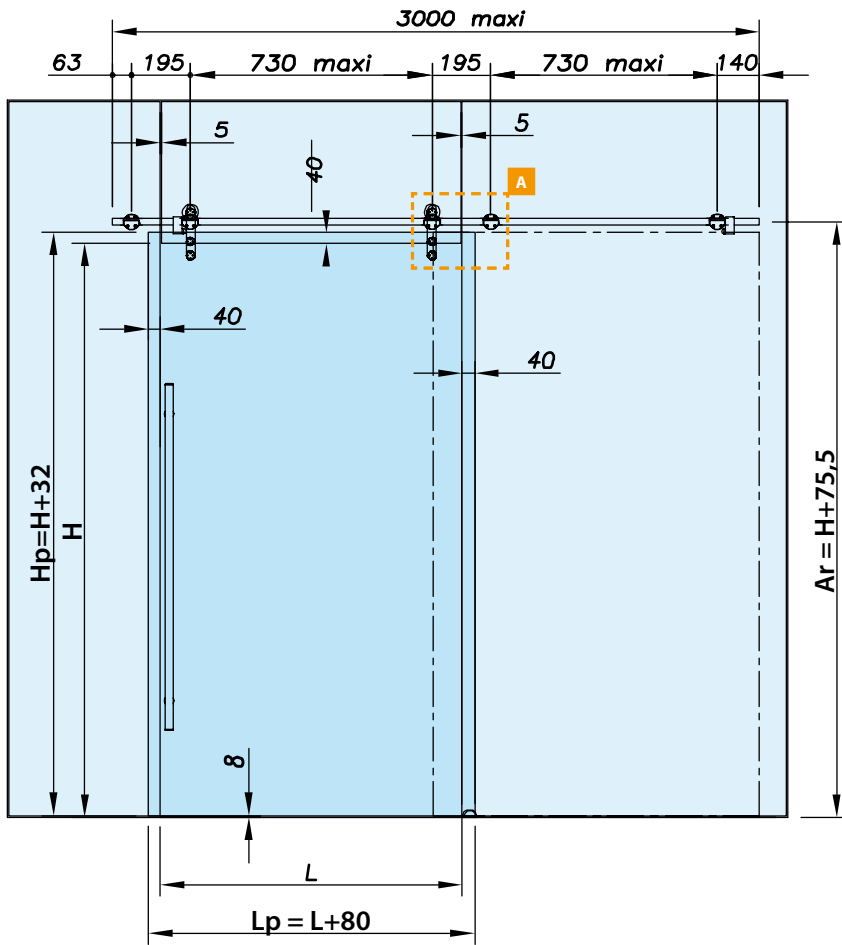



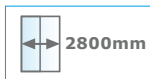

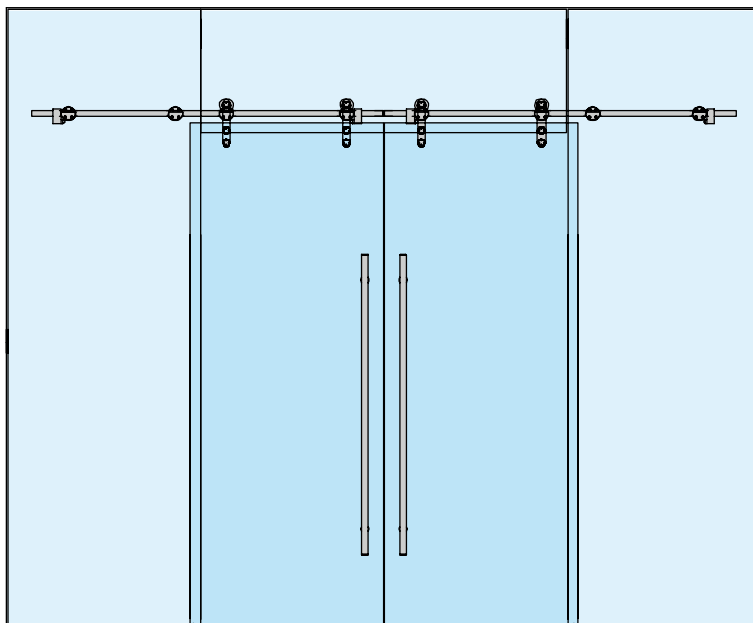

BV01/08 (8mm)
BV01/10 (10mm)
BV01/12 (12mm)



- Kit scorrevole a due ante. Fissaggio su vetro.
- Kit para dos puertas. Fijación en el vidrio.
- Two-leaf sliding door kit. Glass mount.
- Set Schiebetüren mit zwei Flügel. Befestigung auf Glas.



in kit

4X	BV10		Pinza per vetro.
			Pinza por vidrio.
			Grip for glas.
			Zange für Glas.
4X	BV30		Fermo fine corsa.
			Seguro.
			Limit stop.
			End-stopp.
2X	BV40		Binario con tappi di chiusura: Ø25mm L=3000mm.
			Via con tapónes: Ø25mm L=3000mm.
			Track with closing plug: diameter 25mm L=3000mm.
			Anbringen des Gleises an das Glas einschliesslich anti-abtrennelement.
1X	BV41		Connettore per binario. Diametro 25mm.
			Conector por la via. DÍámetro 25mm.
			Track connector. Diameter 25mm.
			Verbindungsstück. Diameter 25mm.
8X	BV70/08 (8mm) BV70/10 (10mm) BV70/12 (12mm)		Attacco del binario a vetro comprensivo di antisganciamento
			Enganche de la via a vidrio, con seguro.
			Attachment of the track to the glass inclusive anti-detachment element.
			Anbringen des Gleises an das Glas einschliesslich anti-abtrennelement.
2X	BN50		Guida a terra.
			Guja al suelo.
			Floor guide.
			Boden-führung.

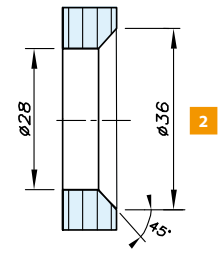
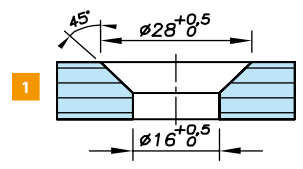
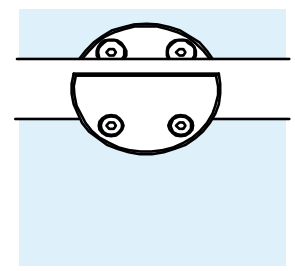
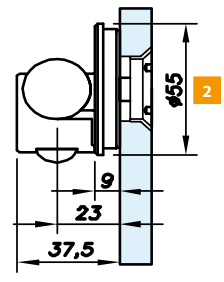
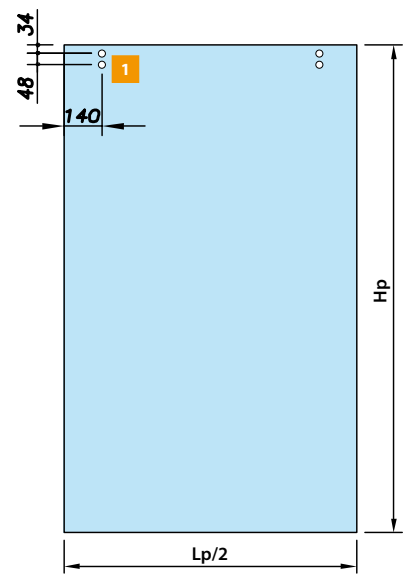
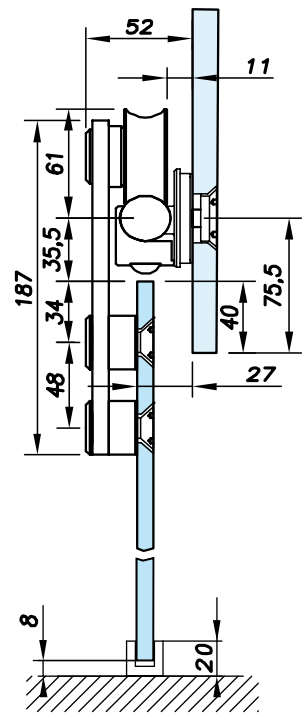
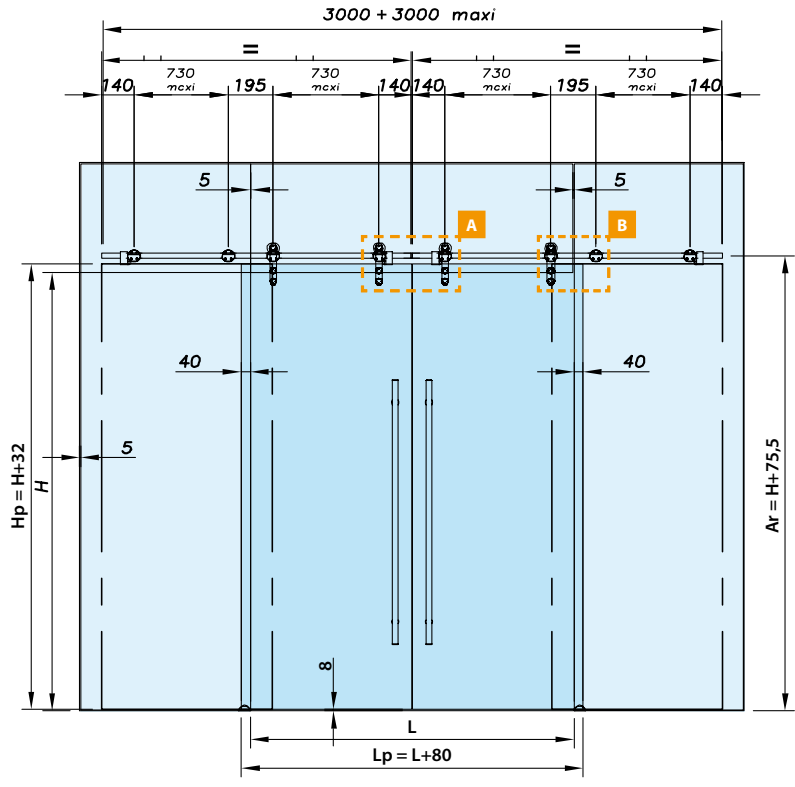
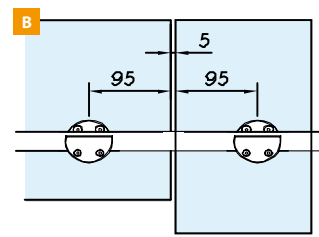
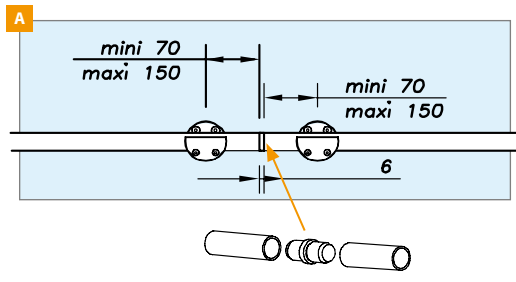





BV05

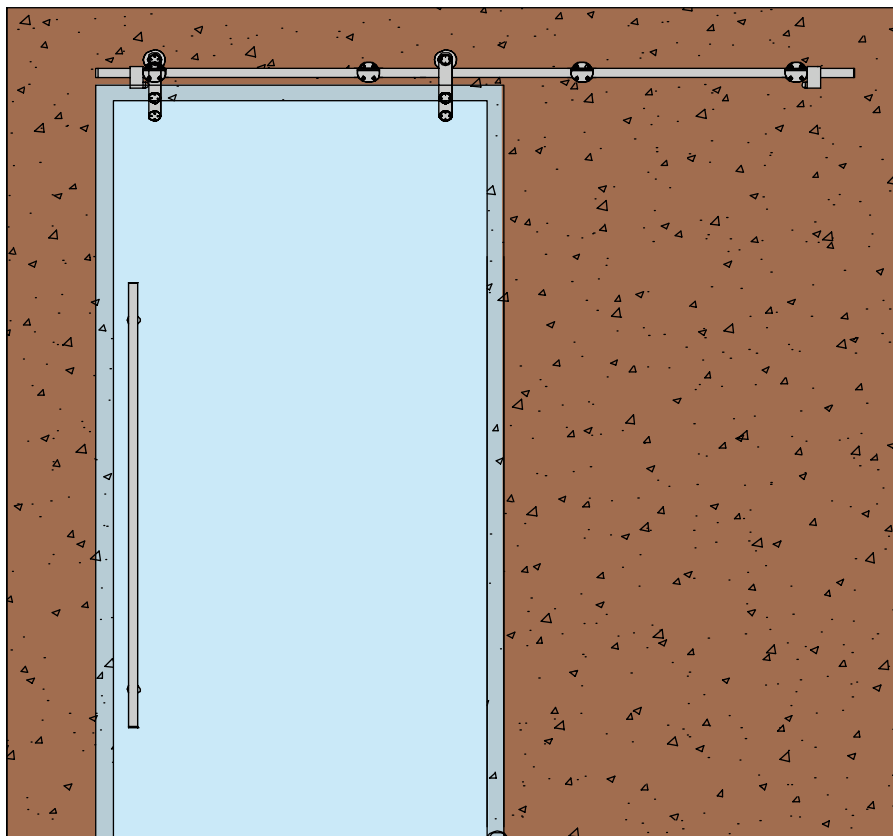

- Kit scorrevole ad un'anta.
Fissaggio su muro.
- Kit para una puerta.
Fijación en la pared.
- One-leaf sliding door kit.
Wall mount.
- Set Schiebetüren mit einem Flügel.
Befestigung an der Wand.



in Kit

2X	BV10		Pinza per vetro.
			Pinza por vidrio.
			Grip for glas.
			Zange für Glas.
2X	BV30		Fermo fine corsa.
			Seguro.
			Limit stop.
			End-stopp.
1X	BV40		Binario con tappi di chiusura: Ø25mm L=3000mm.
			Via con tapónes: Ø25mm L=3000mm.
			Track with closing plug:diameter 25mm L=3000mm.
			Anbringen des Gleises an das Glas einschliesslich anti-abtrennelement.
4X	BV80		Attacco del binario a muro.
			Enganche de la via a la pared.
			Attchment of the track to the wall.
			Anbringen das Gleises an die Wand.
1X	BN50		Guida a terra.
			Guja al suelo.
			Floor guide.
			Boden-führung.

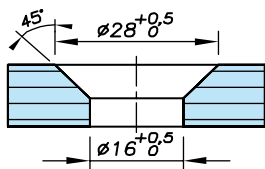
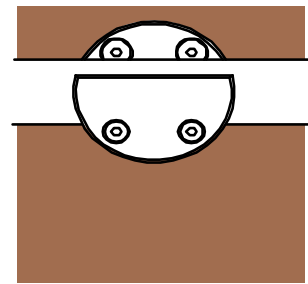
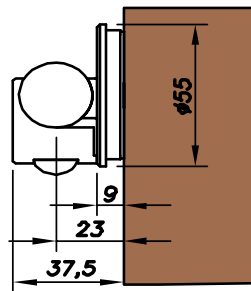
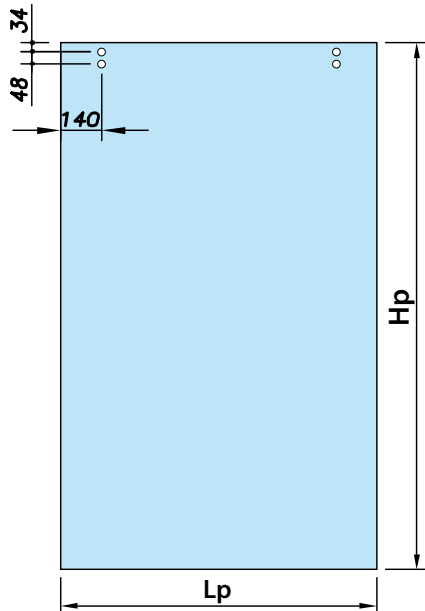
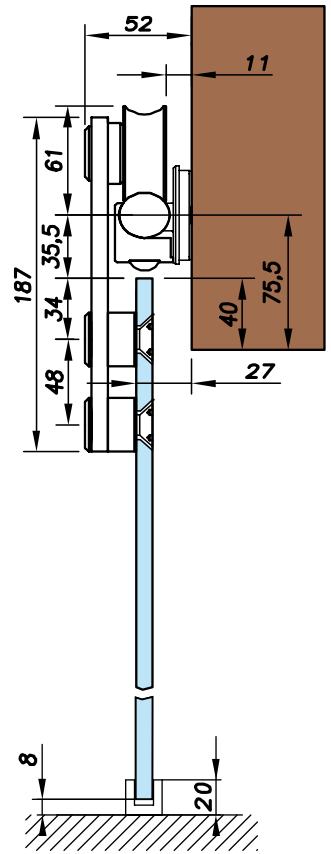
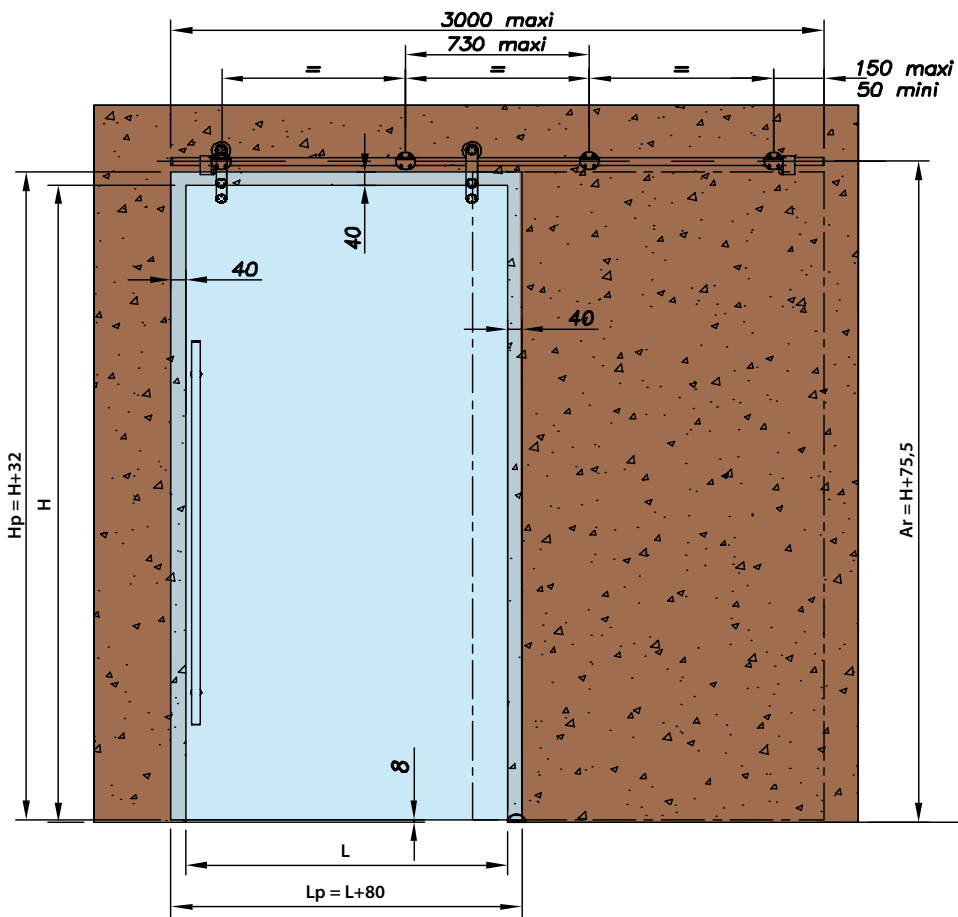





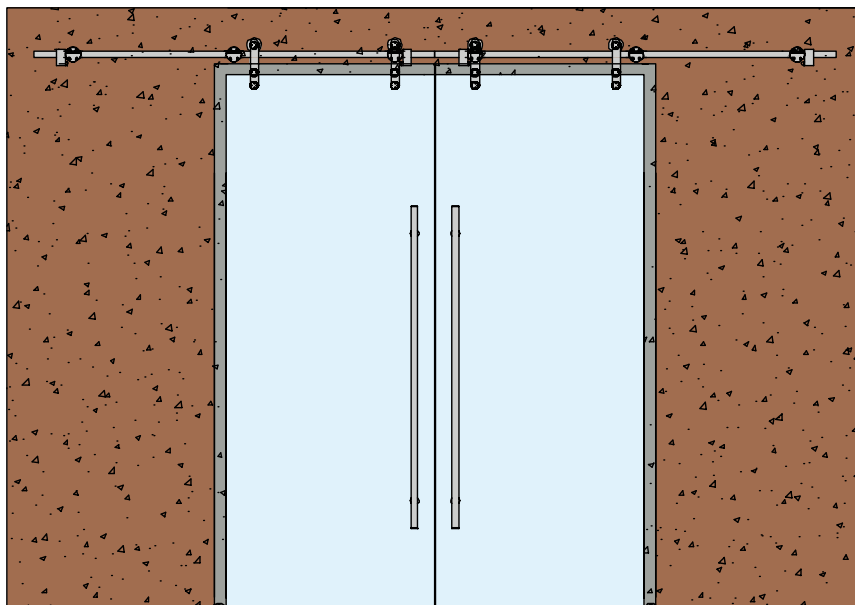

BV06



- Kit scorrevole a due ante.
Fissaggio su muro.
- Kit para dos puertas.
Fijación en la pared.
- Two-leaf sliding door kit.
Wall mount.
- Set Schiebetüren mit zwei Flügel.
Befestigung an der Wand.



in kit

4X	BV10		Pinza per vetro.
			Pinza por vidrio.
			Grip for glas.
			Zange für Glas.
4X	BV30		Fermo fine corsa.
			Seguro.
			Limit stop.
2X	BV40		Binario con tappi di chiusura: Ø25mm L=3000mm.
			Via con tapónes: Ø25mm L=3000mm.
			Track with closing plug:diameter 25mm L=3000mm.
			Anbringen des Gleises an das Glas einschliesslich anti-abtrennelement.
1X	BV41		Connettore per binario. Diametro 25mm.
			Conectador por la via. DÍámetro 25mm.
			Track connector. Diameter 25mm.
			Verbindungsstück. Diameter 25mm.
8X	BV80		Attacco del binario a muro.
			Enganche de la via a la pared.
			Attchment of the track to the wall.
			Anbringen das Gleises an die Wand.
2X	BN50		Guida a terra.
			Guja al suelo.
			Floor guide.
			Boden-führung.

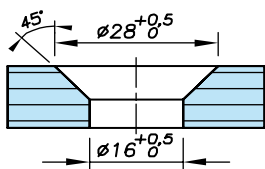
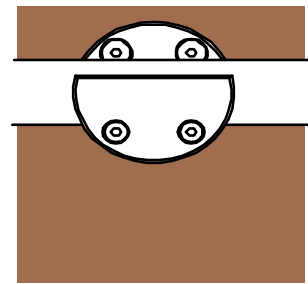
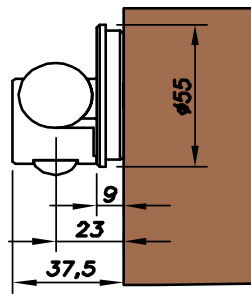
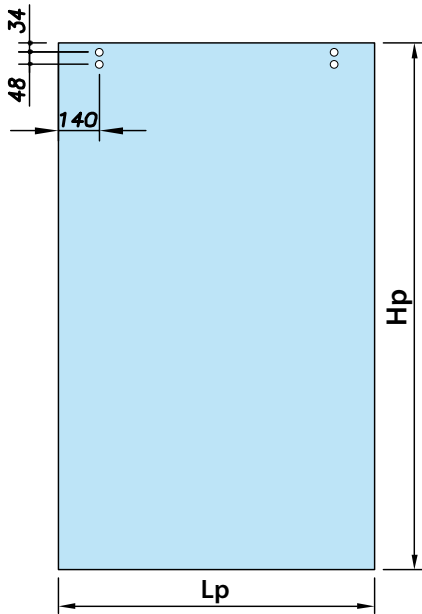
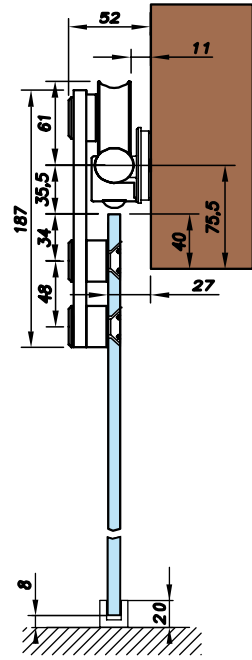
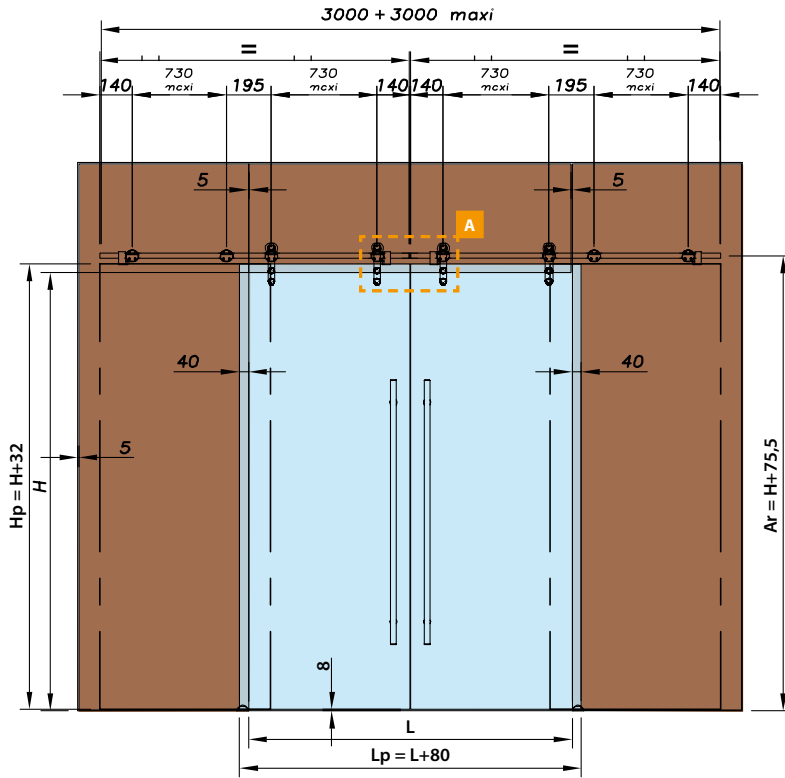
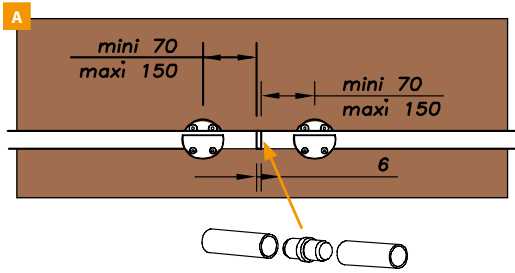



We Build the Invisible

Colcom Group S.p.A.

Tel. (+39)0302532008 - (+39)0302530289

Fax. (+39)0302534707

colcomgroup.it

Via degli Artigiani, n° 56 int.1 - 25075 Nave (Brescia) - Italy

We Build the Invisible

